

 **texi**®



 **texi**® *Fox 25*

▶▶▶ *clever sewing*

texi Fox 25

Automatic multifunctional sewing machine

main functions:

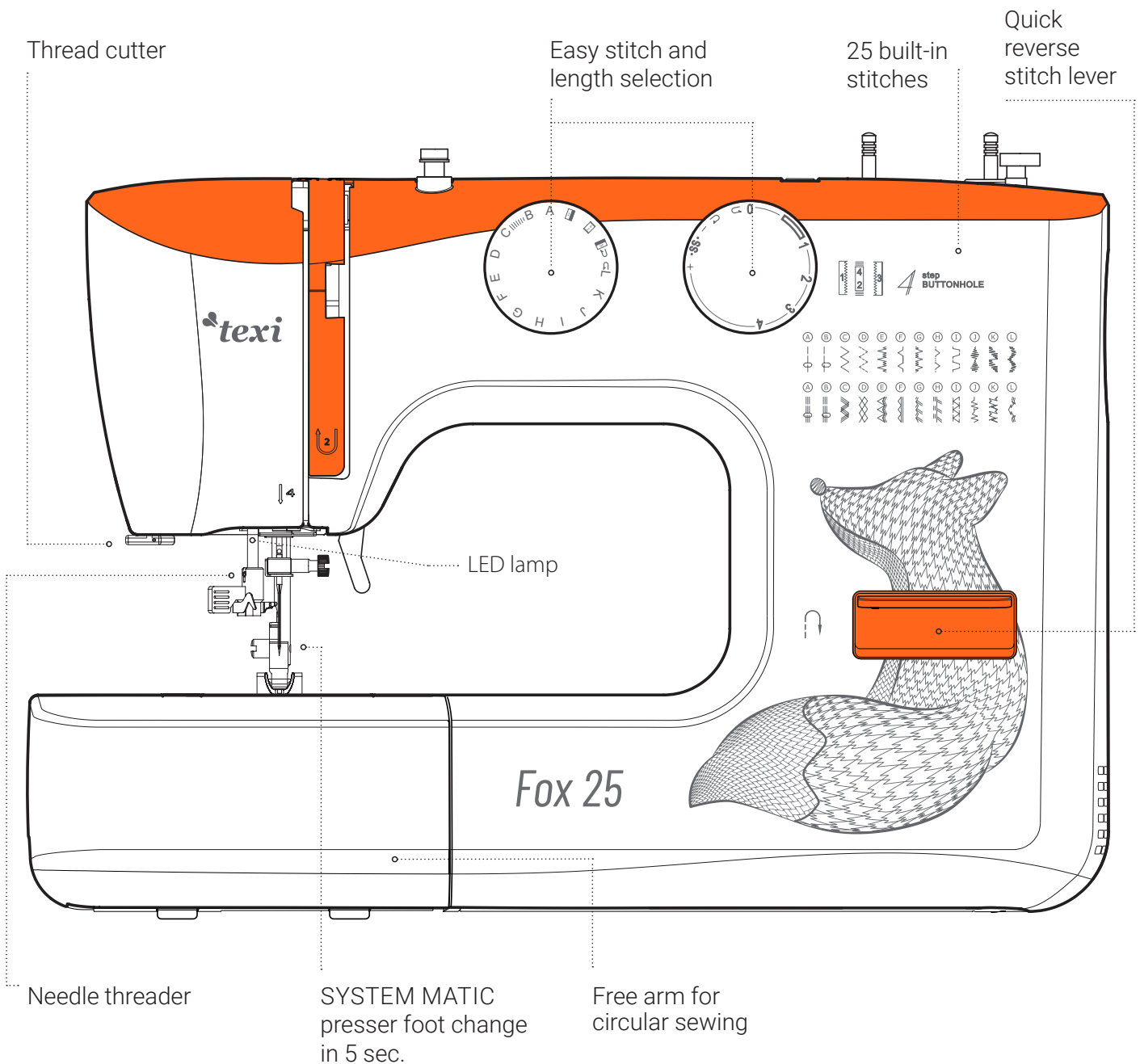



25 built-in stitches (including straight, zig-zag and decorative, 4-step buttonhole)

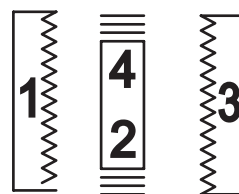
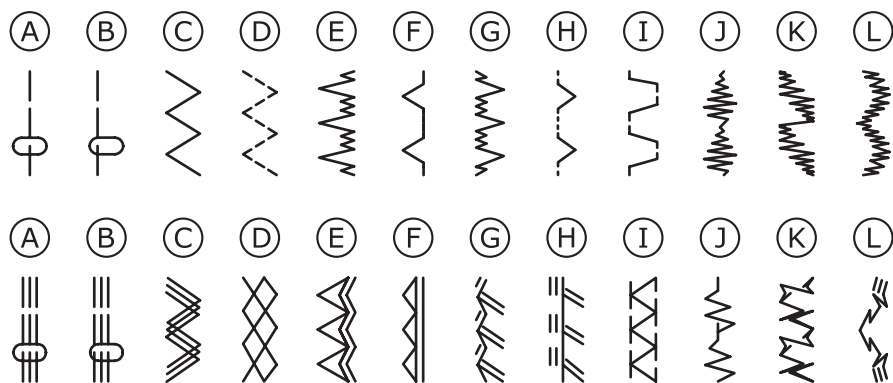

extras inside:

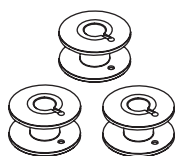

Bobbins



Needle set

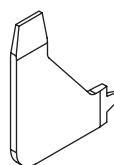

Multi-function
screwdriver

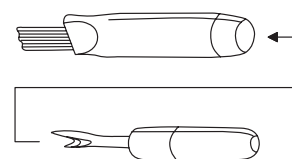

Ripper/Brush

contains a set of snap-on feet
SYSTEM MATIC

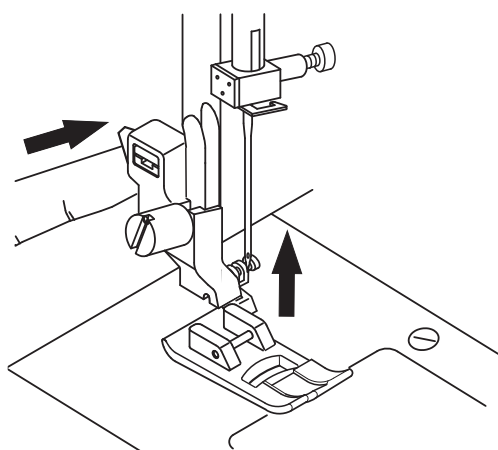

feet in standard:

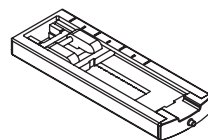

Buttonhole foot

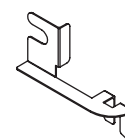

Hem guide

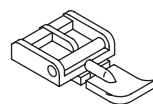

Zipper foot

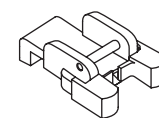

Presser foot for
sewing buttons

we recommend:

buy on
www.strima.com

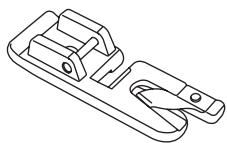

Double hemming foot
TEXI 1010



Sewing
and shirring foot
TEXI 0010

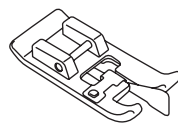

Overcast guide foot
TEXI 1013

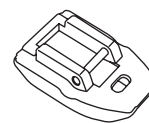

Invisible zipper foot
TEXI 1015

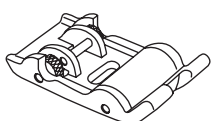

Roller foot for
difficult fabrics
TEXI 1016

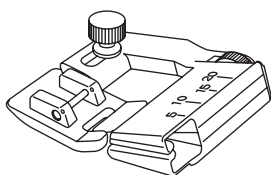

Binder foot
TEXI 1017



Thread cutter
TEXI 4022

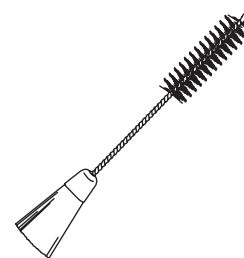

Lint brush
for machines cleaning
TEXI 4017

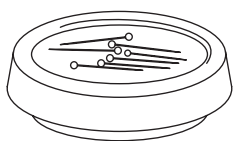

Magnetic pin
and needle holder
TEXI 4029

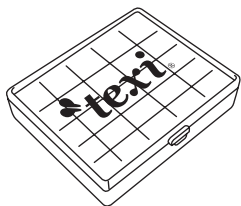

Storage box
for 25 bobbins
TEXI 4033



Bag for household sewing machine
ENJOY BAG FOR HOUSEHOLD SEWING MACHINE